

Capacity 2 Bikes

MATERIALS

Square Steel Tube
1.97" x 1.97" (50 mm x 50 mm)
Thickness: 0.189" (4.8 mm)
Weight: 34.15 lbs. (15.5 kg)

FINISHES

- Powder Coated
- Galvanized
- Stainless

OPTIONAL

- Tamper-proof nuts

SPACING REQUIREMENTS

For details and recommendations on clearance and aisle width please refer to our Bicycle Parking Guide and local regulations and guidelines.

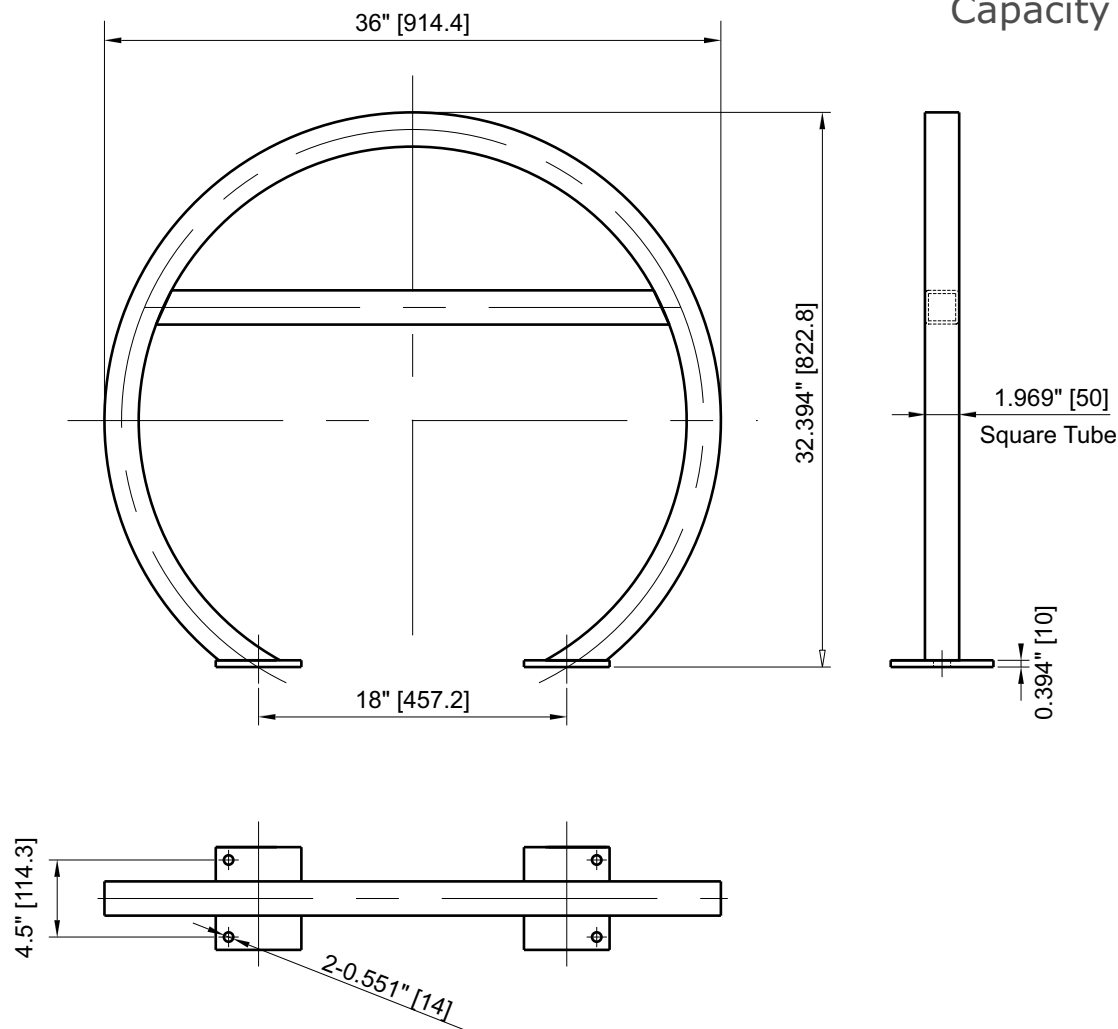

Drawings are for informational purposes only. While correct at the time of design, Kinetic Parking Solutions, Inc. must confirm their accuracy prior to submission.